







KDL BEACON LAMP FLEXIBLE BODY



Features

- Homologated, ECE R65, ECE R10 CE
- 2K injection Technology
- Warm gear mechanism
- Special bulb holder (SERKO DESIGN)
- Screw less assembly design
- The lens and the body are fixed with a special locking system
- Motor vibration is absorbed
- High quality DC motors specially designed for SERKO
- Cables can be customized according to customer request
- %100 tested before delivery
- EMC approved



PARTS	PARTS NAME	PARTS NO
	KDL BEACON LAMP FLEXIBLE BODY WITH SOCKET AMBER	0001.3004.XXX
	KDL BEACON LAMP FLEXIBLE BODY WITH SOCKET RED NOT HOMOLOGATED	0001.3004.XXX
	KDL BEACON LAMP FLEXIBLE BODY WITH SOCKET BLUE NOT HOMOLOGATED	0001.3004.XXX
	KDL BEACON LAMP FLEXIBLE BODY WITH CABLE AMBER	0001.3004.XXX
	KDL BEACON LAMP FLEXIBLE BODY WITH CABLE RED NOT HOMOLOGATED	0001.3004.XXX
	KDL BEACON LAMP FLEXIBLE BODY WITH CABLE BLUE NOT HOMOLOGATED	0001.3004.XXX

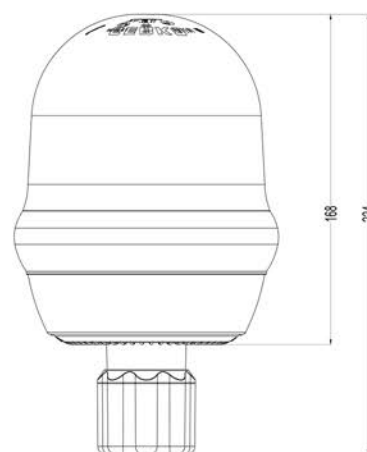
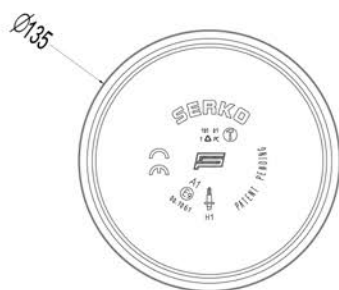

BULB	
12 V 55 W H1	0001.2002.000
24 V 70 W	0001.2041.000

LENS	
AMBER	0001.0062.001
RED	0001.0062.002
BLUE	0001.0062.000